



Technology
desking



COMMAND & CONTROL



Control Room Furniture

Technology Desking.

Established in 1992, Technology Desking specialise in the design, manufacture and installation of furniture products focused on managing technology in the workplace.

From our original UK offices, we have expanded internationally to include additional offices in both Asia and North America. Together with a number of committed alliance partners, we support our customers at a local level anywhere in the world.



CONTROL

Control Console	6
Custom Design	14
SmartArm	16
Zgo Arm	20
Technology Links	22
Smart Storage	24
Integrated Technology	28
Task Chairs	30
Irys Pod	32
Break-Out	34
Contact	38





Adaptable Upgradeable

Technology Desking offer a wide range of technology housing solutions meaning we always have the console to meet your needs.

For more information about the options available please speak to a member of our sales team.



Control Consoles

One Frame.
Multiple Applications.

Our standard control room desk frame offers wide adaptability to meet the 24 hour needs of a variety of control room environments.

Fully ergonomically compliant and offering a range of IT management solutions the Control Console range offers a uniformed aesthetic across all your critical environments.

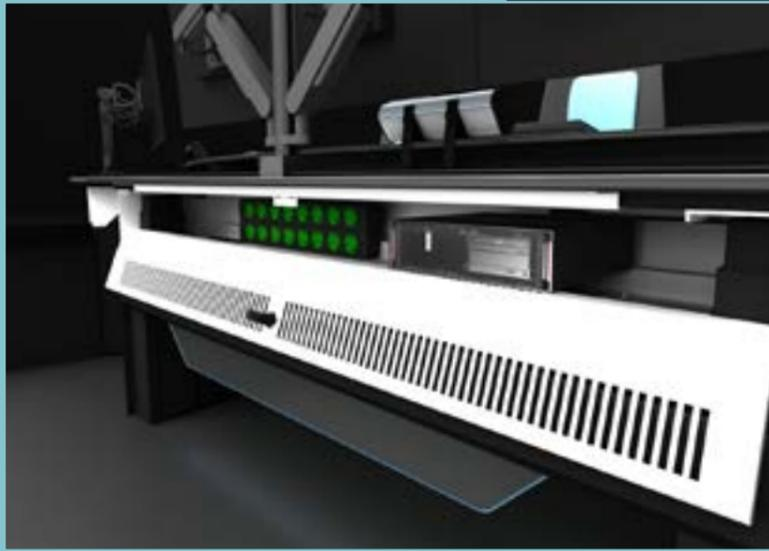

A

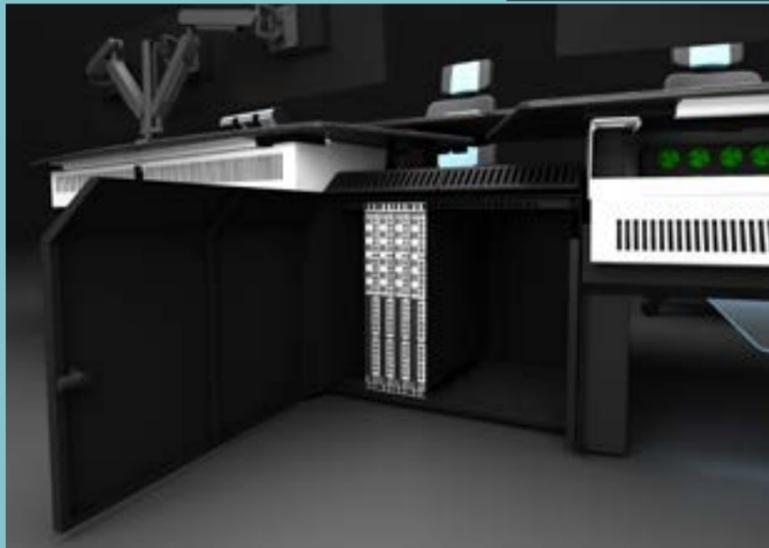

B

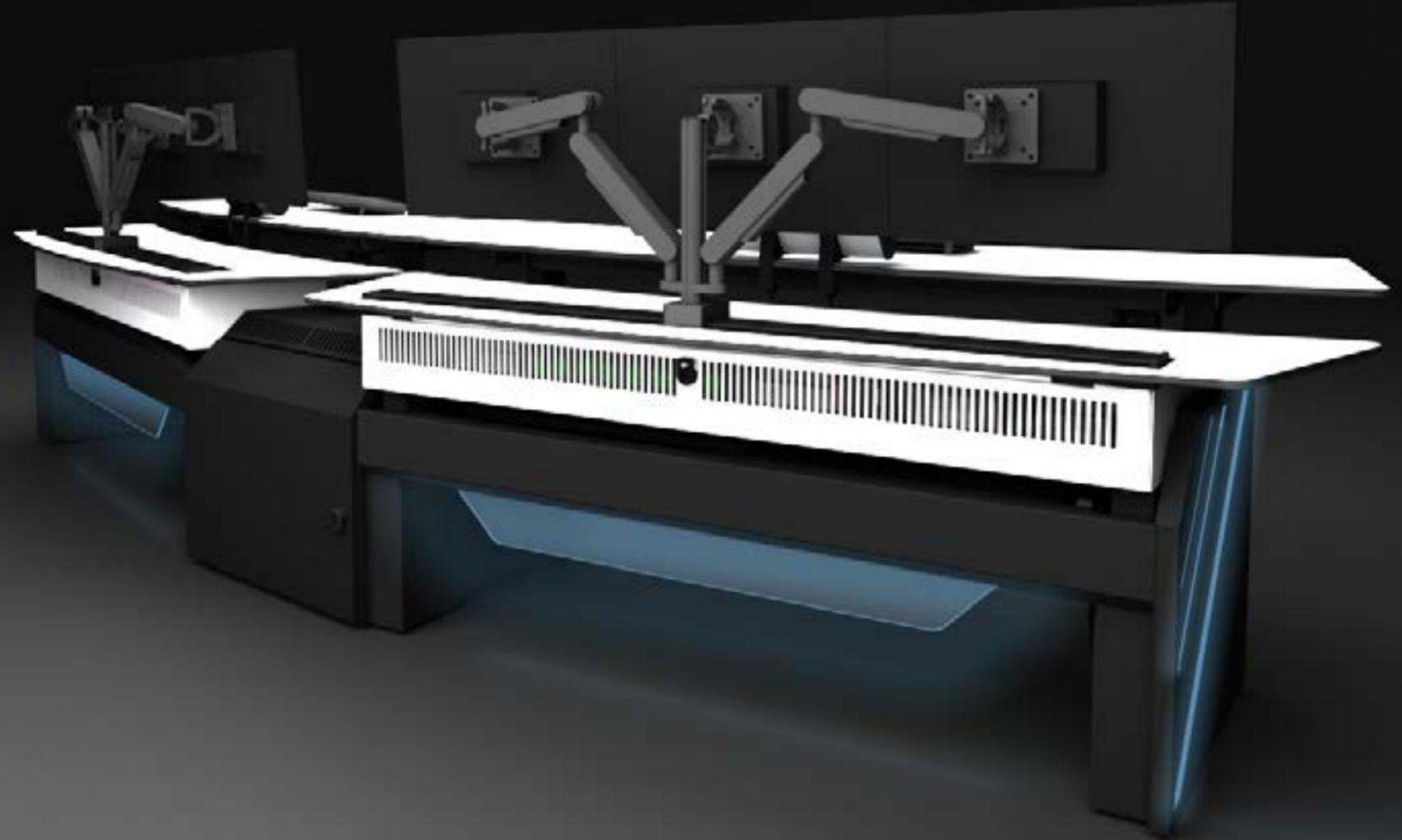

Evolving Technology. Requirements Met.

Each user position has the capacity to house upto 2 small form factor PC's locally as well as options for power/ data/remote processor mounting.

In addition, for larger equipment including 19" rack mounting, housings can be added inbetween desk frames.

Rear access prevents disruption to users in a 24 hour environment.

- A Dynamic technology enclosure for small equipment and power at each user position.
- B Large techology enclosure between user positions can accomodate larger PC's and 19" rack mounting.

Height Adjustment:
Modern Technology.
Premium Functionality.



In a 24 hour environment a height adjustable desk gives the controller the opportunity to regularly change their position while still maintaining full focus. Our desks meet BS EN 527:1 and BS EN ISO 11064-4 ergonomic standards.

Optional dual height adjustable worksurfaces also enable the monitors to be adjusted independently to increase the viewing range within the room.

- A Dual electric height adjustment.
- B Single electric height adjustment.

We utilise the very best in height adjustment technology, both in quality and functionality. Our trading desks boast an adjustment range of 660mm and lower movement noise when compared with market alternatives.

We offer a range of controller styles, from basic up/down controls to advanced LED paddles incorporating Bluetooth connectivity and programmable heights.

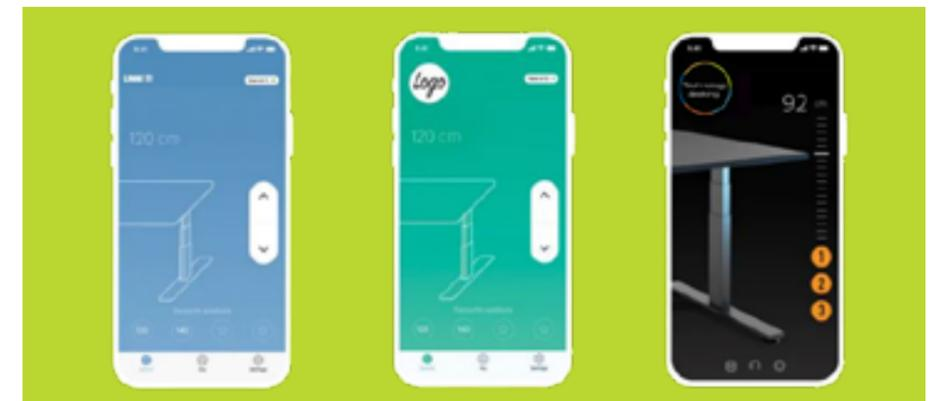

Many control centre operations require the operator to be constantly monitoring vast amounts of information on a bank of monitors.

The number of monitors needed for this function is often the driver in specifying the right control room console for your business needs.

We offer a range of curved consoles which facilitate the requirement for multiple monitors while maintaining optimal viewing distances. All of which are customisable on a project-by-project basis

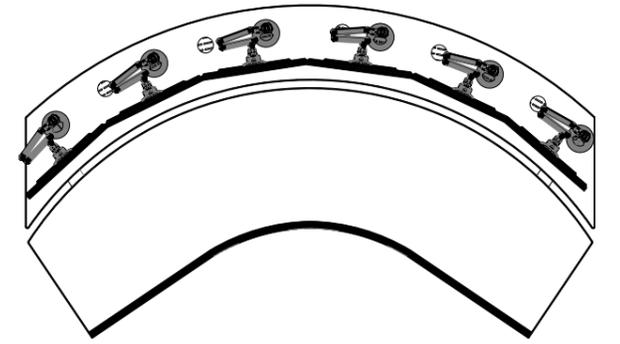

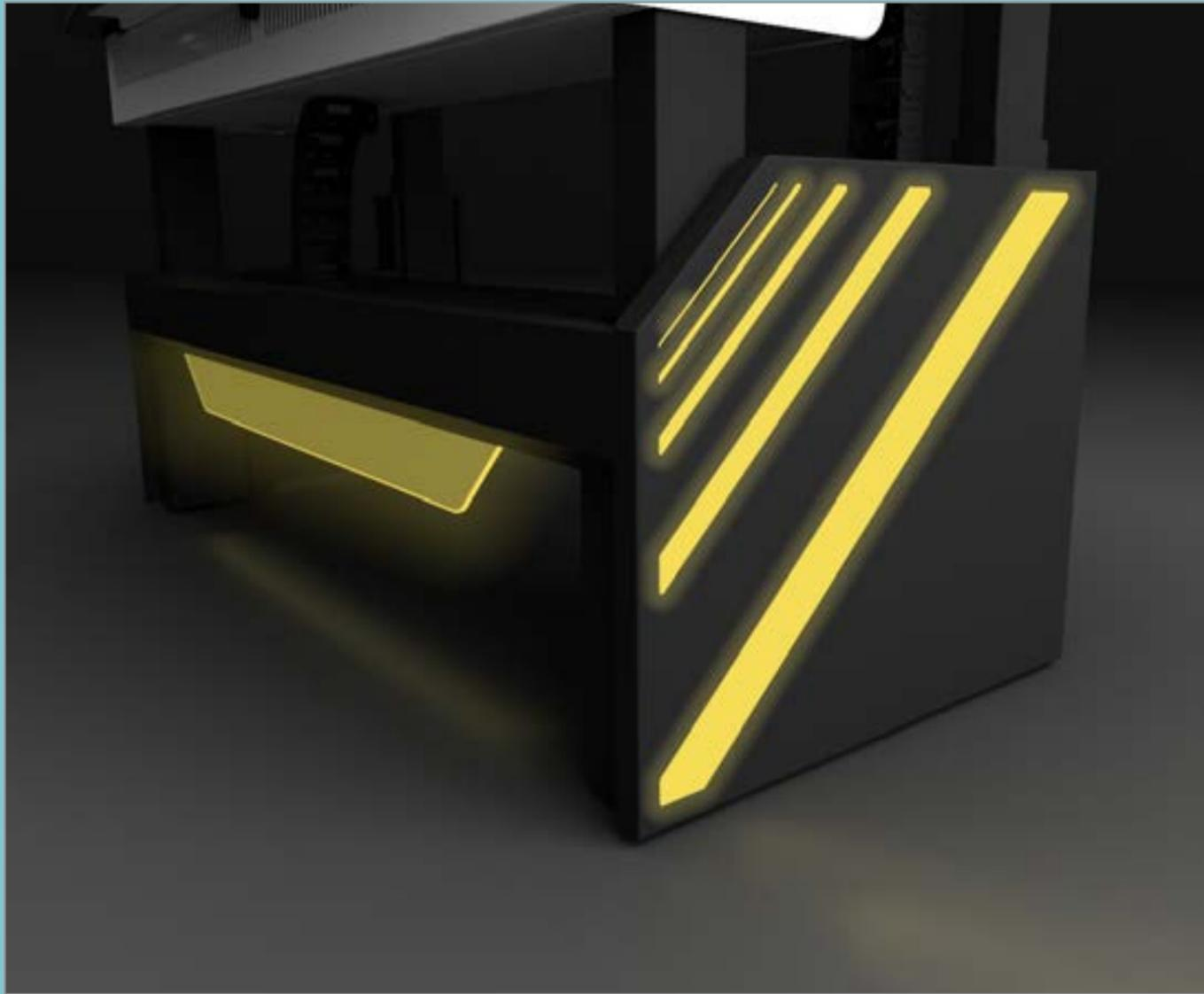

Often dimly lit control rooms require a level of ambient lighting and task lights for users. Lighting can be incorporated into the desk frame and end panelling of our control consoles either as white, RGB or a combination of both. Temperature settings can be pre specified while the whole system can be integrated into your Building Management System.

Customisable panels are available for corporate branding and task lights can be added to desktop level to aid focussed work.





Monitor Arms - SmartArm.

Fully Adjustable, Multi-tier Mounting.

SmartArm is our flat panel monitor mounting system, featuring quick and easy monitor removal, fine height adjustment and complete flexibility.

The system is designed to meet changing monitor specifications and configurations, allowing for either landscape or portrait orientation. Extensions can be added with no disruption to existing monitors.

Our monitor arms offer the perfect solution for layouts with multiple screens.

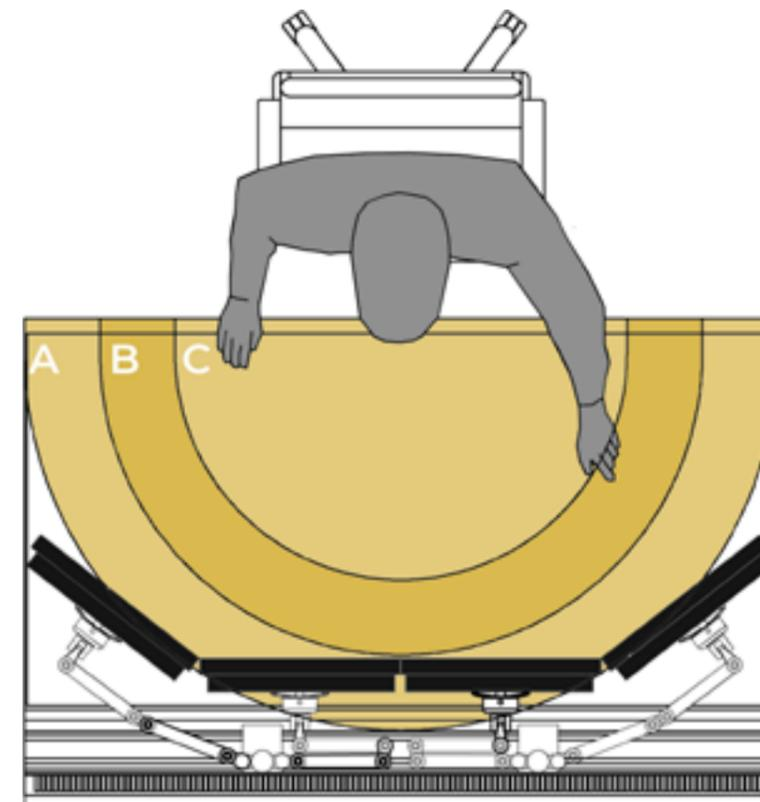
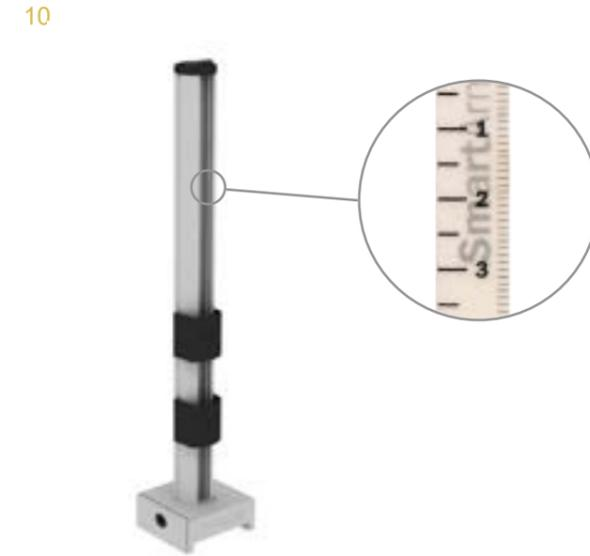
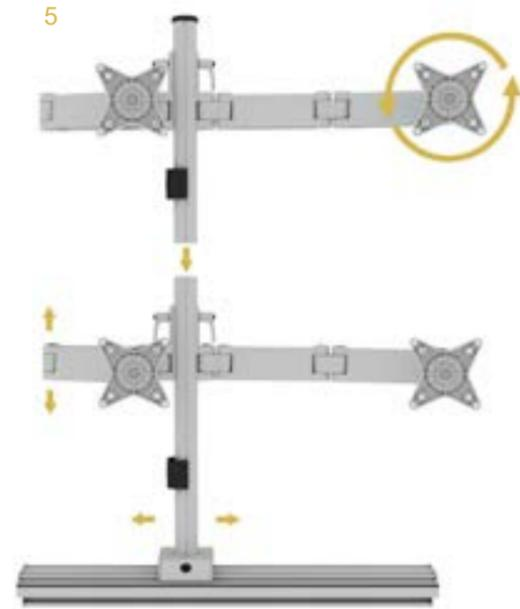
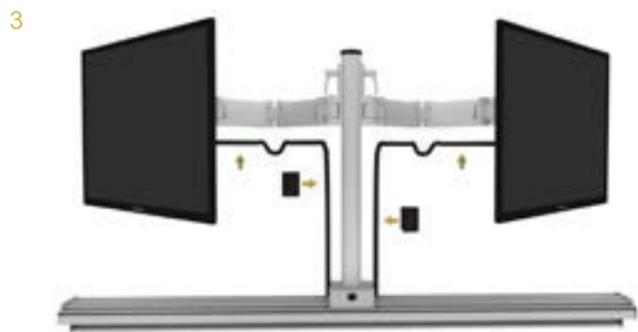
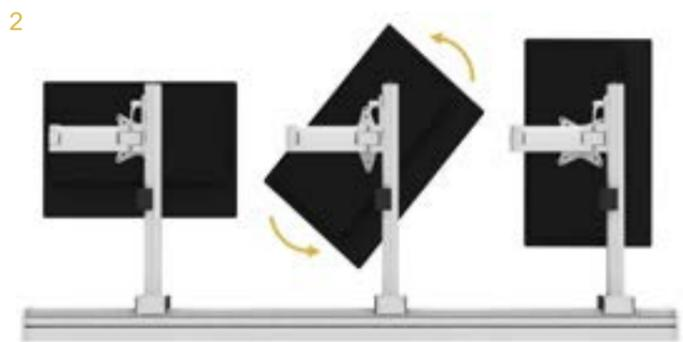

- 1 Fine height adjustment and locking slide bracket.
- 2 Quick release VESA hub for tilt and swivel monitor movements.
- 3 Concealed cable management.
- 4 Arms are configured for maximum adjustability.
- 5 Reconfigurable system enables you to add and take arms on day two.
- 6 Monitor rail, through grommet or desk edge clamp mounting options.
- 7 No link arm
- 8 One link arm.
- 9 Two link arm.
- 10 Integrated ruler so heights can be set to match.
- 11 Choice of three colours; silver, black and white.
- A Maximum viewing distance: 750mm
- B Optimal viewing distance: 600mm
- C Minimum viewing distance: 450mm



Monitor Arms - ZPX.

Endless Possibilities .

The tension sprung Zgo monitor arm provides complete flexibility for the modern control centre. With ZPX arms can be configured as up to 6 with one mounting pole, including options for mounting laptops and tablets.

A modular design with fully incorporated cable management coupled with a wide range of colour options and customisable magnetic panels ensure that ZPX can adapt to meet the varying needs of your room while always fitting in with your business identity.



Technology Links.



Unique Connections.

Technology Links is our unique, fully customisable desktop connectivity solution. PC, power and data outlets are replicated at desktop level to enhance user access and speed up connectivity without the need to search awkwardly under the desk. Modules can be tailored to your specific project requirements.

All of our TL modules with PC outlet connections come with the option of 'Quick Connect' looms allowing PCs to be changed in seconds for rapid swap-out, moves and alterations.

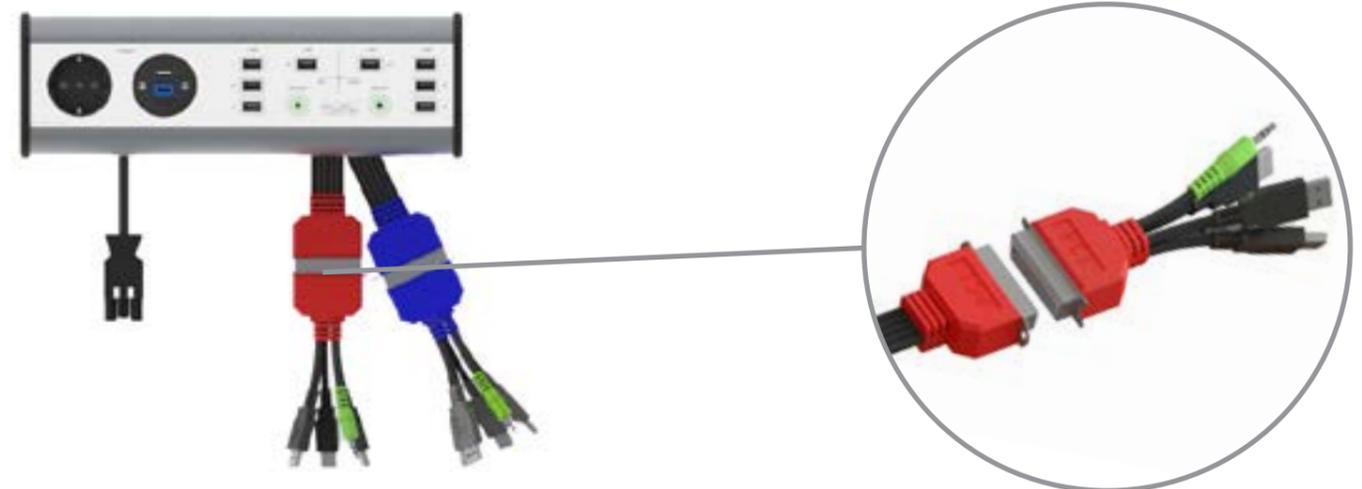



Smart Storage.

Flexible Working.
Reduced Storage.

'Simplicity' keyless locking technology enables a locker to be assigned to an individual when they come into the office, and unassigned again when they leave, with a simple red and green LED light system informing users when a locker is already occupied.

This 'hot-lockering' approach to storage significantly reduces the need for areas dedicated to personal storage within the building.

With Releezme your storage system is connected to the internet enabling users to easily find and access available lockers on their smartphone. This increases flexibility for both the user and facilities management.

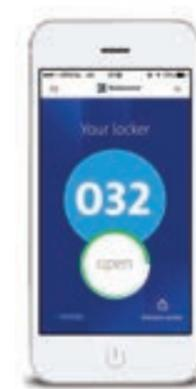

Integrated Technology.

Smart Office.
Smarter Working.

Aura's digital solutions are designed to work natively with commercial displays offering enhanced corporate messaging, streamlined communications and simplified broadcasting.

With room booking management and wireless casting technology, Intevi's solutions can integrate throughout your workplace incorporating features such as occupancy sensors to provide real time analytics and space optimisation to reduce overall costs.

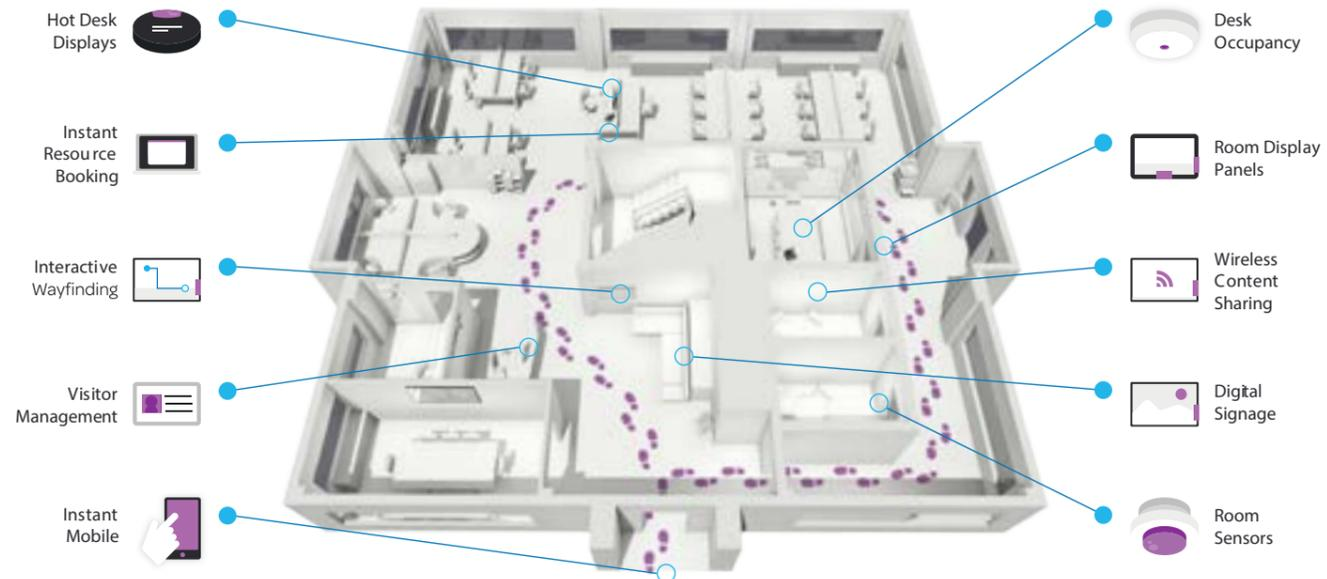



Task Chairs.

You Choose.
We Provide.

We work with a number of partners to offer a select range of 'finishing furniture' for your project

Complete your office with a task chair to provide your workforce with the highest level of comfort.

- A Airpad with Headrest
- B Joyce IS3
- C Vintage IS5
- D Flokk RH
- E Freedom Headrest
- F Flokk RH Secure 24

Relax. Meet. Collaborate.

The Irys Pod system creates flexible multi-use spaces within your office without the need for planning and with the ability to move, change, and grow with your business.

Whether you're looking for a private office, breakout areas, a meeting room or an informal space, Irys can be tailored to your needs with innovative technology integration and a wide range of finishes.

Irys Pod.





A



C



B



D



E

Break Out.

Contemporary Working.
Timeless Style.

Add a comfortable break-out environment away from the desk to complete your new space.

Integrate soft seating areas where staff can relax, or collaborative furniture options to encourage flexible working.

- A HM107D High Table with HM58J and K Bar Stools
- B HM991k Sofa
- C HM22A Tub Chair, HM51B2 Stool and HM63H Table
- D HM19 Booth
- E HM44B2 Lounge Chair with G2 Table



Arrange a visit to
your local showroom
today.

EMEA Showroom

Technology Desking Ltd.
Suite 2.01, 30 Harbour Island North
Harbour Exchange Square
London E14 9GE

ukinfo@technologydesking.com
+44 (0) 207 837 3355



North American Showroom

Technology Desking INC.
39 Broadway
Suite 1640
New York NW10006

usinfo@technologydesking.com
+00 (1) 212 257 6998



Asian Sales Office

Technology Desking HK Ltd.
15/F, Hong Kong & Macau Building
156-157 Connaught Road
Central District, Hong Kong

hkinfo@technologydesking.com
+00 (852) 2868 3878



We support projects globally via our regional sales offices. To discover our full range of products or discuss an upcoming project, contact one of our teams.



www.technologydesking.com